



marantz®

Model PM7000 User Guide

Integrated Amplifier

CONTENTS

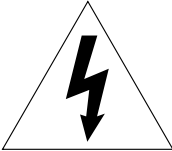
English	page 6
Français	page 15

	CAUTION RISK OF ELECTRIC SHOCK DO NOT OPEN	
CAUTION: TO REDUCE THE RISK OF ELECTRIC SHOCK, DO NOT REMOVE COVER (OR BACK) NO USER-SERVICEABLE PARTS INSIDE REFER SERVICING TO QUALIFIED SERVICE PERSONNEL		

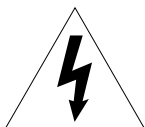

The lightning flash with arrowhead symbol, within an equilateral triangle, is intended to alert the user to the presence of uninsulated "dangerous voltage" within the product's enclosure that may be of sufficient magnitude to constitute a risk of electric shock to persons.



The exclamation point within an equilateral triangle is intended to alert the user to the presence of important operating and maintenance (servicing) instructions in the literature accompanying the appliance.

WARNING

**TO REDUCE THE RISK OF FIRE OR ELECTRIC SHOCK,
DO NOT EXPOSE THIS APPLIANCE TO RAIN OR MOISTURE.**

**CAUTION: TO PREVENT ELECTRIC SHOCK, MATCH WIDE
BLADE OF PLUG TO WIDE SLOT, FULLY INSERT.**

**ATTENTION: POUR ÉVITER LES CHOCS ÉLECTRIQUES,
INTRODUIRE LA LAME LA PLUS LARGE DE LA
FICHE DANS LA BORNE CORRESPONDANTE DE LA
PRISE ET POUSSER JUSQU'AU FOND.**

SAFETY INSTRUCTIONS

READ BEFORE OPERATING EQUIPMENT

This product was designed and manufactured to meet strict quality and safety standards. There are, however, some installation and operation precautions which you should be particularly aware of.

1. Read Instructions — All the safety and operating instructions should be read before the appliance is operated.
2. Retain Instructions — The safety and operating instructions should be retained for future reference.
3. Heed Warnings — All warnings on the appliance and in the operating instructions should be adhered to.
4. Follow Instructions — All operating and use instructions should be followed.
5. Water and Moisture — The appliance should not be used near water—for example, near a bathtub, wash-bowl, kitchen sink, laundry tub, in a wet basement, or near a swimming pool, etc.
6. Carts and Stands — The appliance should be used only with a cart or stand that is recommended by the manufacturer.
7. An appliance and cart combination should be moved with care. Quick stops, excessive force, and uneven surfaces may cause the appliance and cart combination to overturn.



8. Wall or Ceiling Mounting — The appliance should be mounted to a wall or ceiling only as recommended by the manufacturer.
9. Ventilation — The appliance should be situated so that its location or position does not interfere with its proper ventilation. For example, the appliance should not be situated on a bed, sofa, rug, or similar surface that may block the ventilation openings; or, placed in a built-in installation, such as a bookcase or cabinet that may impede the flow of air through the ventilation openings.
10. Heat — The appliance should be situated away from heat sources such as radiators, heat registers, stoves, or other appliances (including amplifiers) that produce heat.
11. Power Sources — The appliance should be connected to a power supply only of the type described in the operating instructions or as marked on the appliance.

12. Grounding or Polarization — Precautions should be taken so that the grounding or polarization means of an appliance is not defeated.

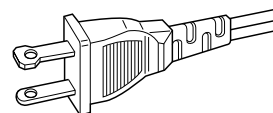

AC POLARIZED PLUG

13. Power-Cord Protection — Power-supply cords should be routed so that they are not likely to be walked on or pinched by items placed upon or against them, paying particular attention to cords at plugs, convenience receptacles, and the point where they exit from the appliance.
14. Cleaning — The appliance should be cleaned only as recommended by the manufacturer.
15. Power Lines — An outdoor antenna should be located away from power lines.
16. Outdoor Antenna Grounding — If an outside antenna is connected to the receiver, be sure the antenna system is grounded so as to provide some protection against voltage surges and built up static charges. Section 810 of the National Electrical Code, ANSI/NFPA No. 70 — 1984, provides information with respect to proper grounding of the mast and supporting structure, grounding of the lead-in wire to an antenna discharge unit, size of grounding conductors, location of antenna-discharge unit, connection to grounding electrodes, and requirements for the grounding electrode. See Fig. 1.
17. Nonuse Periods — The power cord of the appliance should be unplugged from the outlet when left unused for a long period of time.
18. Object and Liquid Entry — Care should be taken so that objects do not fall and liquids are not spilled into the enclosure through openings.
19. Damage Requiring Service — The appliance should be serviced by qualified service personnel when:
 - A. The power-supply cord or the plug has been damaged; or
 - B. Objects have fallen, or liquid has spilled into the appliance; or
 - C. The appliance has been exposed to rain; or
 - D. The appliance does not appear to operate normally or exhibits a marked change in performance; or
 - E. The appliance has been dropped, or the enclosure damaged.
20. Servicing — The user should not attempt to service the appliance beyond that described in the operating instructions. All other servicing should be referred to qualified service personnel.

FIGURE 1
EXAMPLE OF ANTENNA GROUNDING ACCORDING TO
NATIONAL ELECTRICAL CODE INSTRUCTIONS
CONTAINED IN ARTICLE 810 -"RADIO AND TELEVISION EQUIPMENT"

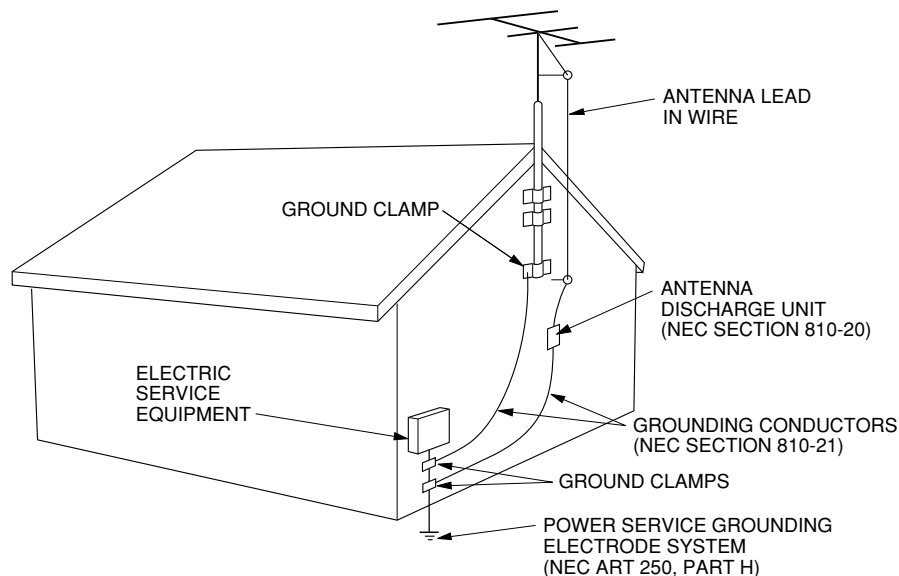

NEC - NATIONAL ELECTRICAL CODE

NOTE TO CATV SYSTEM INSTALLER:

This reminder is provided to call the CATV (Cable-TV) system installer's attention to Article 820-40 of the NEC, which provides guidelines for proper grounding and, in particular, specifies that the cable ground shall be connected to the grounding system of the building, as close to the point of cable entry as practical.

NOTE:

This equipment has been tested and found to comply with the limits for a Class B digital device, pursuant to Part 15 of the FCC Rules. These limits are designed to provide reasonable protection against harmful interference in a residential installation. This equipment generates, uses and can radiate radio frequency energy and, if not installed and used in accordance with the instructions, may cause harmful interference to radio communications. However, there is no guarantee that interference will not occur in a particular installation. If this equipment does cause harmful interference to radio or television reception, which can be determined by turning the equipment off and on, the user is encouraged to try to correct the interference by one or more of the following measures:

- Reorient or relocate the receiving antenna.
- Increase the separation between the equipment and receiver.
- Connect the equipment into an outlet on a circuit different from that to which the receiver is connected.
- Consult the dealer or an experienced radio/TV technician for help.

NOTE: Changes or modifications may cause this unit to fail to comply with Part 15 of the FCC Rules and may void the user's authority to operate the equipment.

This Class B digital apparatus meets all requirements of the Canadian Interference-Causing Equipment Regulations.

Cet appareil numérique de la Classe B respecte toutes les exigences du Règlement sur le matériel brouilleur du Canada.

ABOUT THIS USER'S GUIDE

Figure numbers refer to the illustrations located at the back of this User's Manual. Numbers assigned to parts and controllers match the callout numbers used inside the illustrations.

ALL UPPER-CASE BOLD type indicates the name of a connection or controller as it is actually marked on the amplifier.

PRECAUTIONS

Note the following important precautions whenever operating the amplifier.

SELECTING A LOCATION

Take a few moments to consider the following points before choosing a place for the amplifier.

- Make sure ventilation holes are not blocked or covered.
- Ensure that air can circulate freely around the amplifier.
- Locate the amplifier on a surface that is free of vibration.
- Choose a place where the amplifier will not be exposed to interference from an external source.
- Avoid excessive heat, cold, moisture, and dust.
- Keep the amplifier out of direct sunlight.
- Do not locate the amplifier where it will be exposed to electrostatic charge.

GENERAL SAFETY PRECAUTIONS

- Never place heavy objects on top of the amplifier.
- Should foreign matter or water get into the interior of the amplifier, immediately turn it off and contact your original dealer or Marantz service provider.
- Never pull on the mains lead when unplugging the amplifier. Grasp the plug itself.
- It is always a good idea to disconnect the amplifier from the mains supply whenever leaving it unattended for long periods or during thunderstorms.

CONNECTIONS

(Figure 1)

CONNECTING A TUNER

Connect the output jacks of your stereo tuner to the **TUNER** jacks of this amplifier.

CONNECTING A COMPACT DISC PLAYER

Connect the output jacks of your CD player to the **CD** jacks of this amplifier.

CONNECTING A TURNTABLE

Connect the L (Left) output cord of the turntable to the **"L"PHONO** jack of this amplifier, and the R (Right) output cord to the **"R"PHONO** jack. If the turntable has a ground wire, make sure you connect it to the GND terminal of this amplifier. The GND terminal does not need to be connected if the turntable does not have a ground wire.

CONNECTING A TAPE DECK

Connect the IN (recording input) jacks of the tape recorder to the **TAPE OUT** jack of this amplifier, and the OUT (playback output) jacks of the tape recorder to the **TAPE IN** jack.

CONNECTING A PROCESSOR

Connect the IN jacks of the processor to the **PROCESSOR OUT** jack of this amplifier, and the OUT jacks of the processor to the **PROCESSOR IN** jack. When not used, leave these jacks connected with the supplied connecting pins.

CONNECTING A SPEAKER SYSTEM

Your amplifier has two sets of **SPEAKER SYSTEM** terminals, which means you can connect either one or two speaker systems.

NOTE:

Turn the knobs on the speaker terminals by hand.(Do not use a tool to turn the knobs.)

• CONNECTING ONE SPEAKER SYSTEM

Note the following points when connecting a single speaker system.

- The impedance of each speaker should be minimum 8 ohms. Connecting a speaker with impedance less than 8 ohms can causes activation of the amplifier's protection circuitry during play, making normal stereo playback impossible.
- Connect the right channel speaker to the amplifier's R terminals, and the left channel speaker to the L terminals.
- The output terminals have positive (+: red) and negative (-: black) polarity. Each speaker must also have the same polarity (+/-). Be sure to match the polarity of the amplifier with that of the speakers (+ with +, - with -) when making connections.

• CONNECTING TWO SPEAKER SYSTEMS

Make sure that the impedance of each speaker is minimum 16 ohms. Connecting a speaker with impedance less than 16 ohms can causes activation of the amplifier's protection circuitry during play, making normal stereo playback impossible.

CONTROLS, CONNECTORS, AND INDICATORS

(Figure 2)

① Remote Control Bus Terminals (REMOTE CONT. BUS)

These terminals can be used to connect other audio equipment that is equipped with a remote control bus terminal. Connection requires a special cable. The bus **OUT** terminal sends signal to the connected equipment, while the bus **IN** terminals receive signals.

② AUX1/AUX2 Input Jacks

These auxiliary input jacks can be used to connect the audio output of a **TV** multiplex/stereo audio tuner, **VCR**, laserdisc system, or other **AV** component audio output.

③ Tuner Input Jacks

Connect these jacks to the output jacks of your tuner.

④ CD Input Jacks

Connect these jacks to the output jacks of your compact disc player.

⑤ Phono Input Jacks

Connect these jacks to the output jacks of your turntable. These input jacks are exclusive for a turntable equipped with MM (Moving Magnet) cartridge.

⑥ Tape / CD-R / MD In/Out Jacks

Connect these jacks to the play (output) and record (input) jacks of your recorders. Up to two decks can be connected.

⑦ Processor In/Out Jacks

Use these jacks to connect a graphic equalizer or other analog audio processor. When not used, leave these jacks connected with the supplied connecting pins.

⑧ Ground Terminal

If your turntable has a grounding wire, connect it to this terminal.

⑨ Speaker Systems

Connect your speaker system(s) to these terminals. There are two sets of terminals, so you can connect either one or two speaker systems.

⑩ AC Outlets (Switched)

Connect the power cord of another piece of equipment (VCR, tuner, CD) when you want the power of the connected equipment automatically turned on whenever you turn on this amplifier. For this to work correctly, the power switch of the connected equipment must be left on. Normally, the audio output of the connected equipment is also connected to this amplifier. Note that the total power consumption of the connected all equipment must not exceed 120W.

⑪ Power Cord

Connect the power cord to a standard household power outlet.

⑫ Power Switch

Press this switch to turn power on (depressed) and off (raised). Note that the power of any equipment connected to the switched AC outlet on the rear panel (see 10 above) is also turned on and off by operating this switch.

Turning on the power causes the **POWER** indicator to light, and the **POWER** indicator goes out when power is turned off.

While the **POWER** switch is in the ON position (depressed), you can use the remote control unit's **SYSTEM POWER ON** and **OFF** button to switch the amplifier between standby (indicated when the ⑭ **STANDBY** indicator is lit) and power on.

⑬ Tape,CD-R/MD Selector Buttons

Press one of these switches to select a connected tape deck or CD-R(MD) for monitoring or playback. Pressing a tape, **CD-R/MD** selector switch causes the indicator above it to light.

Pressing **TAPE,CD-R/MD SELECTOR** button while the amplifier is in the Standby Mode automatically turns power back on.

⑭ Input Selector

Use this selector to specify **PHONO,CD, TUNER, AUX 1**, or **AUX 2** as the program source for recording or play. Selecting a program source causes the indicator above it to light. Changing the **INPUT SELECTOR** setting while the amplifier is in the Standby Mode automatically turns power back on.

⑮ Remote Sensor

The remote sensor receives infrared commands from the remote control unit. Note that the remote control unit must be pointed directly at the remote sensor for proper operation.

⑯ Volume Control

Rotate this knob clockwise to increase volume, and counter-clockwise to decrease volume.

⑰ Muting Indicator

This indicator lights when muting is activated by pressing the remote control unit's **MUTING** button.

IMPORTANT:

Be sure to double check the **VOLUME** control setting before pressing the remote control unit's **MUTING** button to cancel muting. Restoring audio output while the **VOLUME** control setting is too high can damage your speakers.

⑱ Balance Control

Rotate this knob to shift the balance of stereo output left and right. Note that turning the **BALANCE** control all the way in either direction causes output from the other side to be eliminated entirely.

19 Record (REC) Selector Switch

Use this switch to select recording between the tape deck and CD-R(MD) or recording of the signal selected by the **INPUT SELECTOR SWITCH** and output from the **REC OUT** jacks. See the note under "Tape Deck CD-R(MD) Operation on page 9 for full details about settings.

20 Source Direct Switch

Press this switch to turn source direct on (depressed) and off (raised).

When source direct is turned on, the audio signal path is as short and direct as possible in order to enjoy high-quality sources under the best conditions possible.

NOTE:

Tape and CD-R(MD) playback and recording are not possible when the **SOURCE DIRECT** switch is on. The **tone** and **BALANCE** controls are also disabled. Any graphic equalizer or other such component that is connected to the **PROCESSOR IN/OUT** jacks will not have any effect. In order to use any of these components or controls, it is necessary to turn the **SOURCE DIRECT** switch off.

21 Bass and Treble Tone Controls

Use these controls to control the levels of their corresponding frequency bands. **TREBLE** adjusts the high frequency band, while **BASS** adjusts the low frequency band. Rotating a control towards (+) enhance the frequency band, while rotating towards (-) attenuates the frequency band.

22 Seaker Switches 1/2

Use these switches to turn speaker output on (depressed) and off (raised). You can turn off speaker output when listening to output over headphones.

23 Phones Jack

Use the jack to plug in headphones that are equipped with a standard phone jack.

24 Standby Indicator

This indicator is lit while the amplifier is in the Standby Mode. Pressing the remote control unit's **POWER** buttons switches the amplifier between standby and power on.

OPERATION

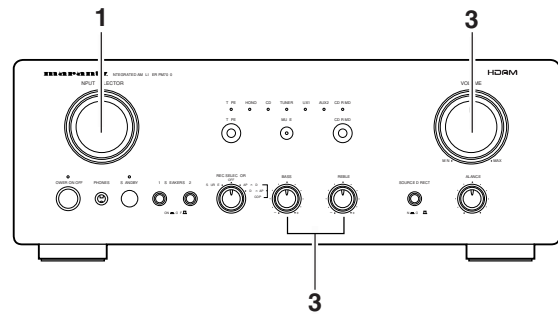

2 Perform the applicable operation on the connected equipment.

TO PLAY AN ANALOG RECORD

1. Set **INPUT SELECTOR** to **PHONO**.
2. Play the record on the turntable.
3. Use **VOLUME** to adjust volume, and **BASS** and **TREBLE** to adjust the tone.

NOTE:

- Be sure the set **VOLUME** to is minimum setting before placing the stylus onto the record or before replacing the turntable's cartridge.
- Never subject the turntable to shock or vibration while a record is playing. This can cause the stylus to jump and possible damage the record.
- Locating your turntable too close to the speakers can cause howling, which will make it impossible to use higher volume settings.
- Never turn off power while the stylus is in contact with the surface of the record.

TO LISTEN TO AN FM/AM BROADCAST

1. Set **INPUT SELECTOR** to **TUNER**.
2. Tune in the desired station on the tuner.
3. Use **VOLUME** to adjust volume, and **BASS** and **TREBLE** to adjust the tone.

TO PLAY A COMPACT DISK

1. Set **INPUT SELECTOR** to **CD**.
2. Play a CD on the CD player.
3. Use **VOLUME** to adjust volume, and **BASS** and **TREBLE** to adjust the tone.

TO PLAY EQUIPMENT CONNECTED TO THE AUX 1 OR AUX 2 JACKS

1. Set **INPUT SELECTOR** to **AUX1** or **AUX2**.
2. Set up the connected equipment for play.
3. Use **VOLUME** to adjust volume, and **BASS** and **TREBLE** to adjust the tone.

TAPE DECK CD-R/MD OPERATION

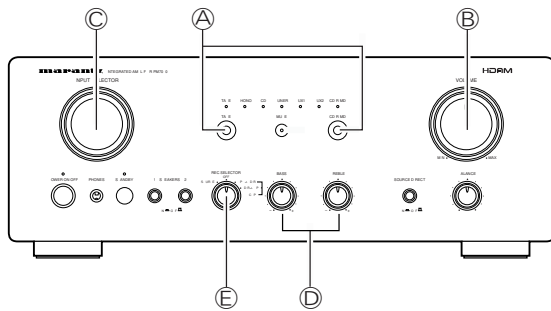

PERFORM THE APPLICABLE OPERATION ON THE CONNECTED TAPE DECK.

TO PLAY BACK FROM A TAPE

1. Press **TAPE** (A) to the indicator above the switch is lit.
2. Play a tape on the tape deck.
3. Use **VOLUME** (B) to adjust volume.
4. Use **BASS** and **TREBLE** (C) to adjust the tone.

NOTE:

You can play back from a tape regardless of the **INPUT SELECTOR** (C) setting.

TO RECORD TO A TAPE

1. Set **INPUT SELECTOR** (C) to **PHONO**, **CD**, **TUNER**, **AUX 1**, or **AUX 2** to select the source you want to record from.
2. Use the **REC SELECTOR** (E) (see below) to specify the type of recording you want to perform.
3. Start play on the selected source.
4. Perform the applicable operation on the connected tape deck to record the output from the selected source.

USING THE REC SELECTOR

Use the **REC SELECTOR** (E) to specify the type of recording you want to perform.

1. The **OFF** setting cuts off all signal output from the **REC OUT** jacks. Note that **REC SELECTOR** (E) should normally be in the **OFF** setting except when you are recording to tape. The **OFF** setting shortens the signal path within the amplifier, which minimizes crosstalk and other factors that can cause deterioration of the sound.
2. **SOURCE** sets up for recording the signal from the source selected by **INPUT SELECTOR** (C).
3. **COPY** sets up for recording from **TAPE** to **CD-R**, or from **CD-R** to **TAPE**. You can listen to the output from another source while recording in the **COPY** position by selecting the source you want with **INPUT SELECTOR** (C).

NOTE:

The **SOURCE DIRECT** switch must be turned off (raised) in order to record to a tape deck. Recording will not possible when **SOURCE DIRECT** is turned on (depressed).

REMOTE CONTROL UNIT RC 8000PM

The RC8000PM remote control unit can be used to control any Marantz AV equipment that has a remote sensor, as well as other Marantz equipment connected to the main equipment's remote control bus. The buttons of the remote control unit are arranged on the control panel according to functional groups as shown in the illustration below. See the relevant user manuals for details on combination equipment as operation content may differ depending on the equipment combined.

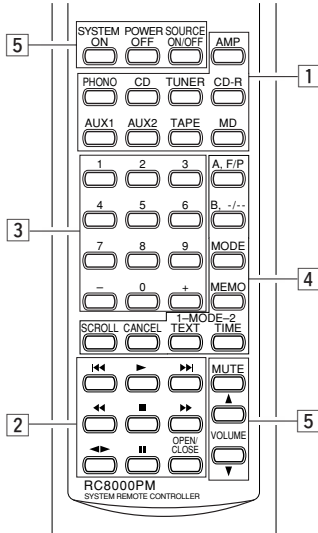

1 Amplifier Source Buttons *1

Use these buttons to select the amplifier's program source.

2 Player Operation Buttons

Use these buttons to control operation of a VCR, CD player, etc.

3 Numeric Key Pad

Use these buttons to input buttons for control of a tuner, CD player, etc.

4 Player/Tuner Auxiliary Operation Buttons

Use these buttons to control the mode switching and track jump operations of a tuner, CD, etc.

5 Amplifier Operation Buttons

Use these buttons to control power on/Standby, volume level, etc.

SYSTEM POWER ON : Power supply is ON for the unit.

SYSTEM POWER OFF : Power supply is OFF for the unit.

SOURCE ON/OFF :

Power supply is ON/OFF for equipment selected by the **1** button.

MUTE : Mutes amp (this equipment's) sound.

VOL ▲ : Increases this equipment's volume.

VOL ▼ : Decreases this equipment's volume.

*1 Pressing an amplifier source button in group **1** to select a source causes the buttons in groups **2**, **3**, and **4** to take on functions to control the selected source equipment (except for PHONO and AMP button). The following tables shows the functions of buttons in these groups for each available amplifier source.

CD BUTTON

The following are the functions assigned to control buttons after the **CD** amplifier source button is pressed.

BUTTON NAME	FUNCTION
▶	Play
▶▶	Fast-forward
◀◀	Fast-reverse
◀▶	None
■	Stop
	Pause
OPEN/CLOSE	Open/Close
+	Next Track
-	Previous Track
A, F/P	Disc Select down
B, -/--	Disc Select up
MODE	Auto Music Scan (AMS)
MEMO	Store
TEXT (MODE 1)	Text
TIME (MODE 2)	Time
▶▶▶	Next Track
◀◀◀	Previous Track
SCROLL	Scroll
CANCEL	Cancel

TUNER BUTTON

The following are the functions assigned to control buttons after the **TUNER** amplifier source button is pressed.

BUTTON NAME	FUNCTION
▶	None
▶▶	Tuning up
◀◀	Tuning down
◀▶	None
■	None
	None
OPEN/CLOSE	None
+	Preset up
-	Preset down
A, F/P	Channel/Frequency/Program
B, -/--	1/2/3 Digits
MODE	Stereo/Mono
MEMO	Store
TEXT (MODE 1)	None
TIME (MODE 2)	None
▶▶▶	None
◀◀◀	None
SCROLL	Display
CANCEL	Cancel

CD-R BUTTON

The following are the functions assigned to control buttons after the **CD-R** amplifier source button is pressed.

BUTTON NAME	FUNCTION
▶	Play
▶▶	Fast-forward
◀◀	Fast-reverse
◀▶	None
■	Stop
	Pause
OPEN/CLOSE	Open/close
+	Next track
-	Previous track
A, F/P	None
B, -/--	None
MODE	Auto Music Scan (AMS)
MEMO	Store
TEXT (MODE 1)	Text
TIME (MODE 2)	Time
▶▶▶	Next Track
◀◀◀	Previous Track
SCROLL	Scroll
CANCEL	Cancel

AUX 2 BUTTON

The following are the functions assigned to control buttons after the **AUX 2** amplifier source button is pressed.

BUTTON NAME	FUNCTION
▶	VCR Play
▶▶	VCR Fast-forward
◀◀	VCR Rewind
◀▶	VCR Play REV/Direction Switch
■	VCR Stop
	VCR Pause
OPEN/CLOSE	VCR Eject
+	Step up
-	Step down
A, F/P	Channel/Presets
B, -/--	1/2/3 Digits
MODE	Sound Select
MEMO	Store (Memo Rew.)
TEXT (MODE 1)	Text↔TV Station
TIME (MODE 2)	Scroll Display (Time)
▶▶▶	VCR Fast Run FWD
◀◀◀	VCR Fast Run REV
SCROLL	None
CANCEL	None

AUX 1 BUTTON

The following are the functions assigned to control buttons after the **AUX 1** amplifier source button is pressed.

BUTTON NAME	FUNCTION
▶	VCR Play
▶▶	VCR Fast-forward
◀◀	VCR Rewind
◀▶	VCR Direction Switch
■	VCR Stop
	VCR Pause
OPEN/CLOSE	Tape Eject
+	Channel/Program up
-	Channel/Program down
A, F/P	Channel/Frequency/Program
B, -/--	1/2/3 Digits
MODE	Sound Select
MEMO	Store
TEXT (MODE 1)	TV Station ↔ Text
TIME (MODE 2)	Scroll Display (Time)
▶▶▶	VCR Fast Run FWD
◀◀◀	VCR Fast Run REV
SCROLL	None
CANCEL	None

TAPE BUTTON

The following are the functions assigned to control buttons after the **TAPE** amplifier source button is pressed.

BUTTON NAME	FUNCTION
▶	Play
▶▶	Fast-Forward
◀◀	Rewind
◀▶	Direction Switch
■	Stop
	Pause
OPEN/CLOSE	Eject
+	Next
-	Previous
A, F/P	Deck A
B, -/--	Deck B
MODE	Auto Music Scan (AMS)
MEMO	Store
TEXT (MODE 1)	Scroll Display (Text)
TIME (MODE 2)	Scroll Display (Time)
▶▶▶	Next
◀◀◀	Previous
SCROLL	None
CANCEL	Cancel

MD BUTTON

The following are the functions assigned to control buttons after the **MD** amplifier source button is pressed.

BUTTON NAME	FUNCTION
▶	Play
▶▶	Fast-forward
◀◀	Rewind
◀▶	Direction Switch
■	Stop
	Pause
OPEN/CLOSE	Eject
+	Next
-	Previous
A, F/P	Edit
B, -/--	Enter
MODE	Monitor
MEMO	Store
TEXT (MODE 1)	None
TIME (MODE 2)	Time
▶▶	Next
◀◀	Previous
SCROLL	Scroll
CANCEL	Delete

USING THE REMOTE CONTROL UNIT

When operating the remote control unit (RC8000PM), point its transmitter directly at the remote sensor, which is located on the front of the amplifier. Make sure the remote control unit is no further than about 5 meters from the remote sensor. Remote control operation may not be possible if the remote control unit's transmitter is not pointing directly at the remote sensor, or if there is an obstruction between the transmitter and sensor.

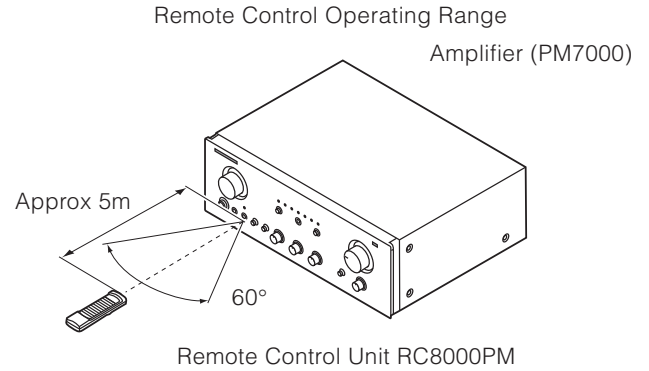

REMOTE CONTROL UNIT BATTERIES

Remote control unit batteries should last for about one year under normal conditions. Replace batteries as soon as possible whenever they show signs of running low. Also, be sure to remove the batteries if you do not plan to use the remote control unit for a long time.

TO LOAD REMOTE CONTROL UNIT BATTERIES

- (1) Remove the battery compartment cover.

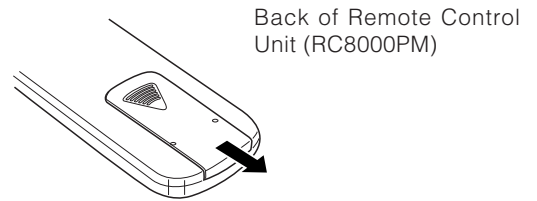

- (2) Load two batteries, making sure their positive (+) and negative (-) ends are facing correctly.

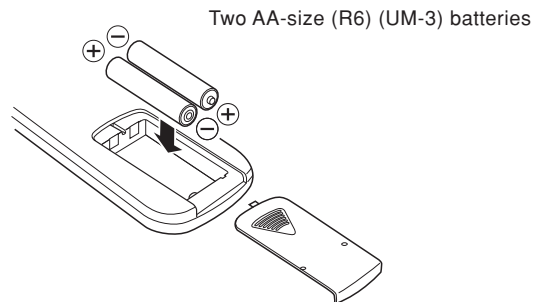

- (3) Slide the battery compartment cover back into place and press until it clicks shut.

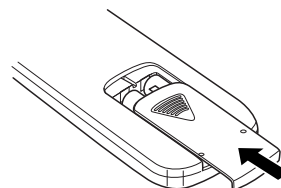

CARE AND MAINTENANCE

This section describes care and maintenance that you must perform in order to make sure your Marantz amplifier performs at the level for which it is designed. Be sure to unplug the amplifier from the mains supply before any care and maintenance.

NORMAL CLEANING

The exterior of your amplifier will last indefinitely with proper care and cleaning. For normal cleaning, wipe exterior surfaces with a soft, lint-free cloth.

IMPORTANT:

Any of the following will mar the finish of your amplifier and should never be used for cleaning.

- Scouring pads, steel wool, abrasive powders
- Harsh chemical agents (such as a lye solution)
- Alcohol, thinners, benzene, insecticide, or other volatile agents.

SPECIAL CLEANING

Should the amplifier ever become so soiled that normally cleaning is not enough, use the following procedure for cleaning.

1. Prepare a cleaning solution of one part mild neutral liquid detergent and six parts water.
2. Moisten a soft, lint-free cloth in the cleaning solution and then wring out all excess moisture from the cloth.
3. Wipe off the amplifier with the damp cloth.
4. Dry the amplifier by wiping it with a soft dry cloth.

REPAIRS

Only the most competent and qualified serviced technicians should be allowed to service this amplifier. Marantz and its factory-trained warranty personnel have the special knowledge and facilities required for the repair and calibration of this amplifier. After expiration of the warranty period, repairs can be performed for a separate charge. Whenever you experience problems, first try to solve the problem yourself using the troubleshooting procedures provided on this page. If this does not work, contact your original dealer or write directly to your nearest service provider as listed on the Marantz Authorised Service Station list. When you write, be sure to include the model and serial number of your amplifier, together with a detailed description of the problem.

TROUBLESHOOTING

Whenever you have a problem with the amplifier, check the following points before requesting service. What may seem to be a serious malfunction is often the result of a simple operational error. If you still have problems, contact your original dealer or write directly to your nearest service provider as listed on the Marantz Authorised Service Station list.

The amplifier does not operate and indicators do not light.

1. Check to see if the power cord is correctly inserted into a power outlet.

Indicators light, but the amplifier does not operate.

1. Check the **SELECTOR** and **VOLUME** settings.
2. Check to see if the supplied connecting pins are correctly inserted into the **PROCESSOR IN/OUT** jacks.

Sound is being produced by only one speaker.

1. Check the **BALANCE** setting.
2. Turn off the amplifier and switch the connections of the left and right speaker cords. If the same speaker still does not produce sound, it probably means that the connection cord or the speaker itself is defective.

Considerable humming is produced when playing from a turntable.

1. Check to see if the plugs from the turntable are properly connected to the amplifier's **PHONO** jacks.
2. Connect the turntable's ground wire to the **GND** terminal on the rear panel of the amplifier. If the ground wire is already connected, try disconnecting it.
3. Check to make sure that the turntable's phono cartridge is securely attached to the tone arm.

Cannot perform remote operation.

1. Make sure the remote control unit's (RC8000PM) transmitter is pointed directly at the amplifier's remote sensor when you perform a remote control unit operation.
2. Check for obstructions between the remote control unit's transmitter and the amplifier's remote sensor.
3. Check the batteries of the remote control unit.
4. Make sure there is no strong light (from a window or other source) shining on the amplifier's remote sensor.
5. Check to see if there is an **RCA** cord connected to the **REMOTE CONTROL IN** jack on the amplifier's rear panel.

MODEL PM7000 TECHNICAL SPECIFICATIONS

Power output

RMS 8 ohms (20 Hz-20 kHz)	95 W
DIN 8 ohms	105 W
THD at 8 ohms RMS rated output	0.03%
Damping factor	150

IHF dynamic power

8 ohms	120 W
--------------	-------

Magnetic cartridge input

Input sensitivity impedance	2.5 mV/47 kOhm
Accuracy of frequency response to IEC RIAA	0.5 dB
Signal to noise ratio	85 dB

Tuner/CD/Aux/Tape inputs

Input sensitivity impedance	150 mV/40 kOhm
Signal to noise ratio	88 dB
Frequency response (-1 dB limits, Source Direct)	10 Hz - 50 kHz
Tone characteristic (100 Hz and 10 kHz)	±8 dB
Channel separation (1 kHz/10 kHz, Source direct)	>80/>70 dB

General

Power Requirements	120 V, 60 Hz
--------------------------	--------------

Dimensions

Width	440 mm
Height	159 mm
Depth	370.5 mm

Weight

Unit alone	12.3 kg
------------------	---------

Specifications subject to change without prior notice.

FIGURES

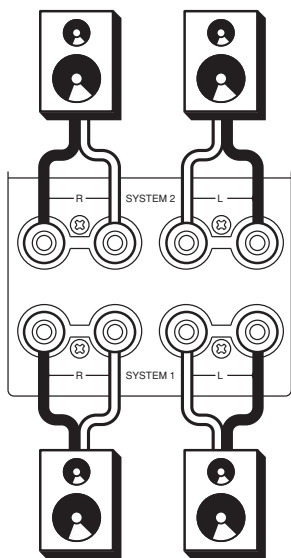
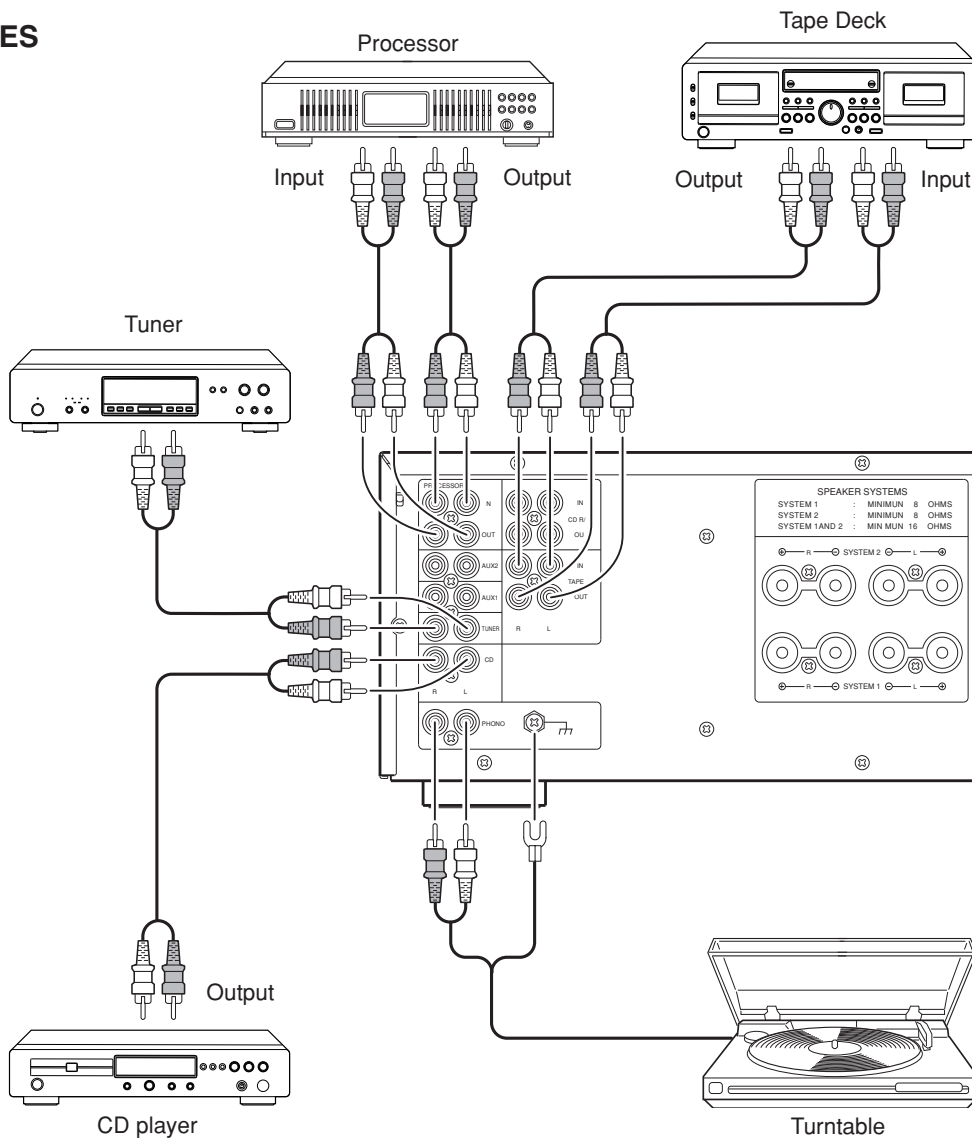

NOTE:

Turn the knobs on the speaker terminals by hand.
(Do not use a tool to turn the knobs.)

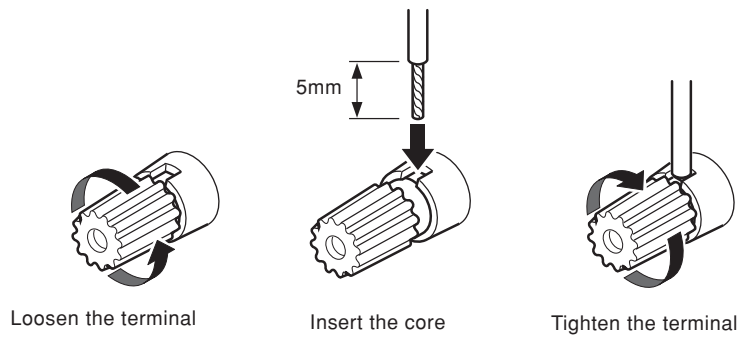

Connection of speaker cable

Figure 1

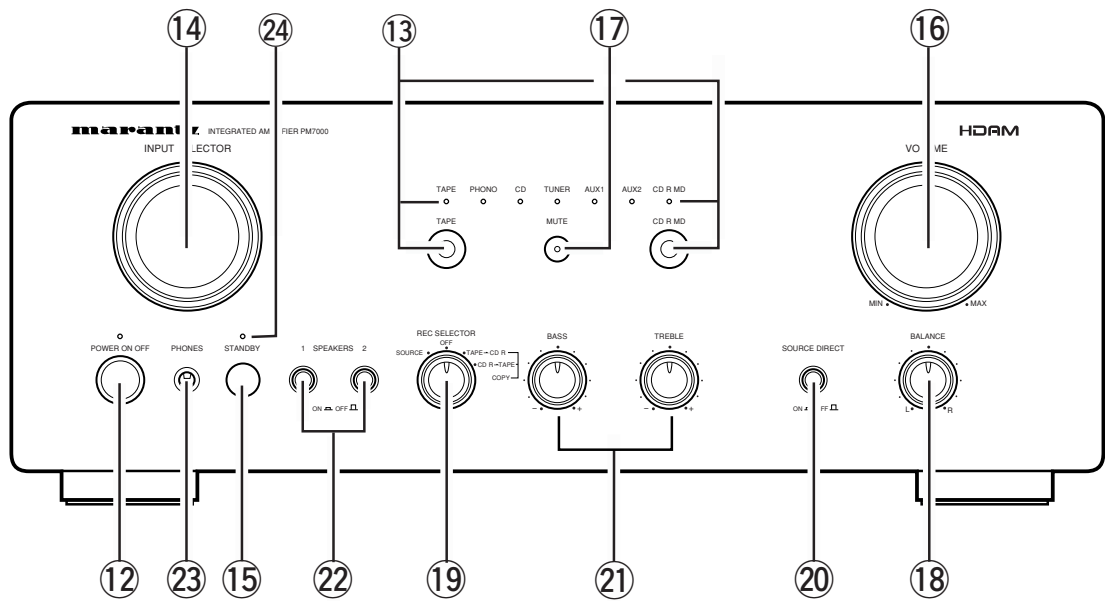
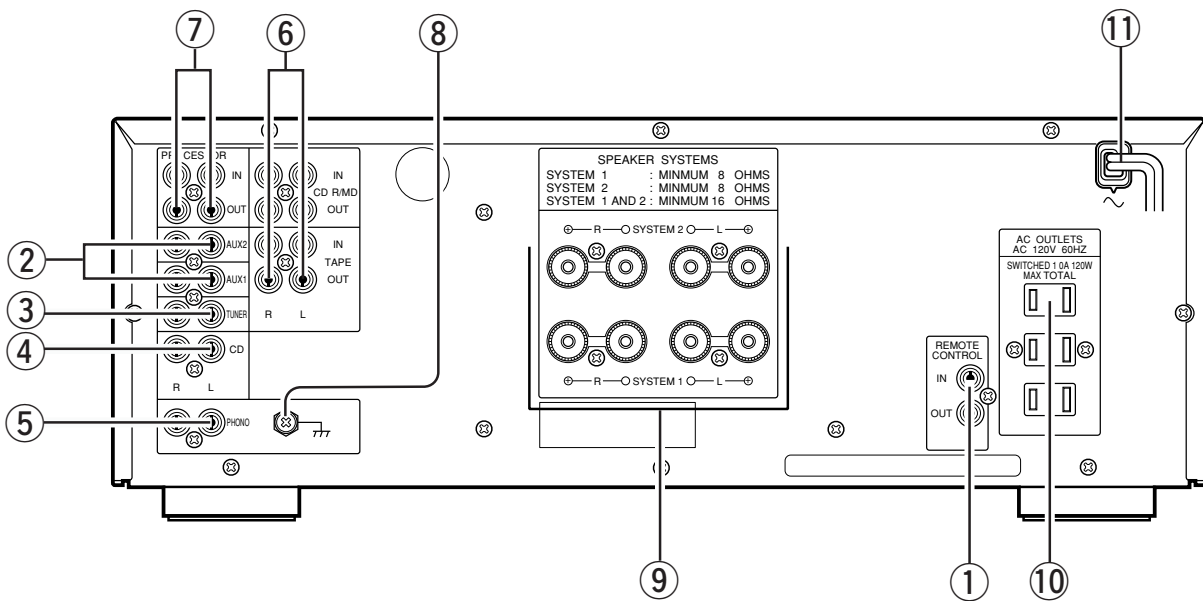

Figure 2

COUNTRY	COMPANY	ADDRESS
AUSTRALIA	Scan audio Pty. Ltd.	4 Station Street, Thornleigh NSW 2120, Australia
AUSTRIA	Huber & Prohaska GmbH	Taborstraße 95 / Ladestraße 1, Gebäude Hangartner, A-1200 Wien, Austria
BELGIUM	Van der Heyden Audio N.V.	Brusselbaan 278, 9320 Erembodegem, Belgium
BULGARIA	Ariescommerce GmbH	Makedonia Blvd. 16, 1606 Sofia, Bulgaria
CANADA	Lenbrook Industries Limited	633 Granite Court, Pickering, Ontario
CYPRUS	Empire Hifi systems Ltd.	P.O. Box 5604, Nicosia, Cyprus
CZECH REPUBLIC	Audio International	Fugnerova 1, 67801 Blansko, Czech Republic
DENMARK	Hi-Fi Klubben Denmark	Aboulevarden 1, DK-8000 Arhus C., Denmark
DUBAI	V.V.& SONS	P.O. Box 105, Dubai, U.A.E.
ESTONIA	Audio International Baltic	Lo Hu 12, EE0026 Tallin, Estonia
F.Y.R.O.M.	T.P. KODI	ul.Cedomir Kantargiev 21a, Skopje, Former Yugoslavian Republic of Macedonija
FINLAND	Hi-Fi Klubi Finland	Uudenmaankatu 4-6, SF-00120 Helsinki, Finland
FRANCE	Marantz France	A division of Marantz Europe B.V., P.O. Box 301, 92 156 Suresnes Cedex, France
GERMANY	Marantz Deutschland	Hakenbusch 3, 49078 Osnabrück, Germany
GREECE	Adamco S.A.	188, Hippocratous Street, 11471 Athens, Greece
HEADQUARTERS EUROPE:	Marantz Europe B.V.	Building SFF-2, P.O. Box 80002, 5600 JB Eindhoven, The Netherlands
HONG KONG	Marantz Asia Ltd.	Unit 1706, Metroplaza II, 223 Hing Fong Road, Kwai Fong, N.T., Kowloon, Hong Kong
HUNGARY	Infovox Ltd.	Terez Krt.31, 1067 Budapest, Hungary
ICELAND	Radiobudin HF	Skipholt 19, P.O. Box 424, 121 Reykjavik, Iceland
INDIA	Marantz India	c/o Philips India Ltd., Plot 80, Bhosari Industrial Estate Pune - 411026, India
IRAN	Home Co.	5th floor no 878 Philips Building Enghelab ave, P.O. 11365/7844 Tehran, Iran
IRELAND	Marantz Ireland	Clonskeagh, Dublin 14, Ireland
ISRAEL	Elmor Ltd.	52 Heh Beiyar Street, Kikar Hamedina, Tel Aviv, Israel
ITALY	Marantz Italy	Via Casati 23, 20052 Monza (Milano), Italy, Servizio Consumatori 1678-20026, Numero Verde
JAPAN	Marantz Japan Inc.	35-1 Sagami Ohno 7-Chome, Sagamihara-Shi, Kanagawa 228-8505, Japan
KOREA	Mk Enterprises Ltd.	121-210, 2F Shinhan Bldg., 247-17 Seokyo-dong, Mapo-ku, Seoul, Korea
KUWAIT	alAlamiah Electronics Intl.	P.O. Box 8196, Salmiah 22052, Kuwait
LATVIA	Ace Ltd.	61, LacPlesa Str., Riga LV 1011, Latvia
LEBANON	AZ Electronics S.A., 1,	P.O. Box 11 2833, Beirut, Lebanon
LITHUANIA	A Accapella Ltd.	Ausros, Vartu G5, Pasazo Skg., 2001 Vilnius, Lithuania
MALAYSIA	Wo Kee Hong Electronics Sdn. Bhd.	102 Jalan SS 21/35, Damansara Utama, 47400 Petaling Jaya, Selangordarul Ehsan, Malaysia
MALTA	Doneo Co Ltd.	78 The Strand, Sliema SLM07, Malta
MAURITIUS	SKR Electronics Ltd.	P.O. Box 685, Bell Village, Port Louis, Mauritius
NETHERLANDS	Marantz Trading	A division of Marantz Europe B.V., Building SFF-2, P.O. Box 80002, 5600 JB Eindhoven, The Netherlands
NEW ZEALAND	Scan audio Pty. Ltd.	4 Station Street, Thornleigh NSW 2120, Australia
NORWAY	Hi-Fi Klubben Norway	Lillegrensen 7, N-0159 Oslo, Norway
OMAN	Mustafa & Jawad Trading CO.	P.O. Box 1918, Ruwi, Oman
POLAND	Marantz Polska	Ul. Marszalkowska 45/49, 00-648 Warszawa, Poland
PORTUGAL	Corel2	Comércio de Electrónica Lda., Av. Luís Bivar, No 85 A, 1050 Lisboa, Portugal
PROFESSIONAL EUROPE	Marantz Professional Products	Kingsbridge House, Padbury Oaks, 575-583 Bath Road, Longford, Middlesex UB7 0EH, U.K.
PROFESSIONAL U.S.A.	Marantz Professional Products	Distributed by: Superscope Technologies Inc., 1000 Corporate Blvd. Ste.D, Aurora, Illino
QATAR	Almana & Partners W.W.L.	P.O. Box 49, Doha, Qatar
REUNION	Vision +	180 Rue du Marechal Leclerc, 97400 Saint Denis, Ile de la Reunion
ROMANIA	Alltrom SRL	Soseaua Bucuresti, Ploiesti 10, Sector 1, Bucharest, Romania
RUSSIA	Trade Company SV	Bld. 2, 7 Montazhnaya Street, 107497 Moscow, Russia
SAUDI ARABIA	Ultimate Fidelity	Sameria Comm. Center, Roadah Dist., P.O. Box 7760, Jeddah 21472, Saudi Arabia
SINGAPORE	Forward Marketing (S) Pte. Ltd.	Wo Kee Hong Centre, 29 Leng Kee Road, Singapore 159099, Singapore
SLOVAKIA	Audio International Slovakia	Nam. SNP 10, 96001 Zvolem, Slovakia
SLOVENIA	Bofex	Smartinska 152, HALA V/3, 61000 Ljubljana, Slovenia
SOUTH AFRICA	Coherent Imports (PTY) Ltd.	P.O. Box 1614, Alberton, 1450, South Africa
SPAIN	Marantz Spain	Martinez Villergas 2, Apartado 2065, Madrid 28027, Spain
SWEDEN	Hi-Fi Klubben A.B.	Tegnersgatan 21, S-412 52 Gotenborg, Sweden
SWITZERLAND	Sound Company AG	Postfach, 8010 Zürich, Switzerland
TAHITI	Covecolor	Av. Prince Hinoi, Cours de l'union sacré, P.O. Box 2334, Papeete, Tahiti
TAIWAN	Pai-Yuing Co. Ltd.	6th No 148 Sung Kiang Road, Taipei 10429, Taiwan R.O.C.
THAILAND	MRZ Standard Co. Ltd.	746-750 Mahachai Road, Wangburapa, Bangkok 10200, Thailand
TURKEY	Penta Elektronik	Sanayi Ve Ticaret Ltd. Sti., Selvi Kokak, No. 4/1, Senlikkoy, 34810 Florya, Istanbul, Turkey
U.K.	Marantz Hifi UK Ltd.	Kingsbridge House, Padbury Oaks, 575-583 Bath Road, Longford, Middlesex UB7 0EH, U.K.
U.S.A.	Marantz America Inc.	440 Medinah Road, Roselle, IL 60172, U.S.A.
YUGOSLAVIA	ITM	Ljutice Bogdana la, Belgrade, Yugoslavia
EXPORT	Marantz Trading	A division of Marantz Europe B.V., Building SFF-2, P.O. Box 80002, 5600 JB Eindhoven, The Netherlands

www.marantz.com

US and foreign patents licensed from Dolby Laboratories Licensing Corporation.

marantz® is a registered trademark.

